

CDP



Family features:

- ▶ Also with wiper function available
- ▶ Hall sensor available
- ▶ Degree of protection: IP 50
- ▶ Operation mode: S1

Voltage	Part number	P _n (Nominal power)	I _n (Nominal current)	n _n (Nominal speed)	M _n (Nominal torque)	M _a (Stall torque)	Gear ratio	Direction of rotation	Signal	Side**	Dimensional drawing (D)	Wiring diagram (W)	Drive end (S)	Connector (C)	Performance curve (P)
		W	A	rpm	Nm	Nm			Hall						
12 V	0 986 337 225*	14.7 ; 20.9	5.5 ; 8	35 ; 50	4	51 ; 39	2:108	CCW	No	L	D1	W1	S1	C1	P4
	0 986 337 270	50.2	10	42	10	45	2:108	CCW/CW	2x	L	D1	W2	S2	C2	P5
	0 986 337 280	38.7	8.5	37	10	40	1:78	CCW/CW	2x	L	D1	W2	S3	C2	P1
24 V	0 986 337 200*	8.5 ; 13.8	2.75 ; 3.75	27 ; 44	3	50 ; 46	1:78	CCW	No	L	D1	W1	S3	C1	P6
	0 986 337 201	20.9	3.5	40	5	30	2:108	CCW/CW	No	L	D1	W3	S2	-	P7
	0 986 337 209*	8.8 ; 14.4	3 ; 4	28 ; 46	3	50 ; 41	1:78	CCW	No	L	D1	W1	S1	C3	P3
	0 986 337 250	50.2	6	80	6	45	2:108	CCW/CW	2x	L	D1	W2	S2	C2	P2

* Motors with two speeds / **gear housing left: L, gear housing right: R

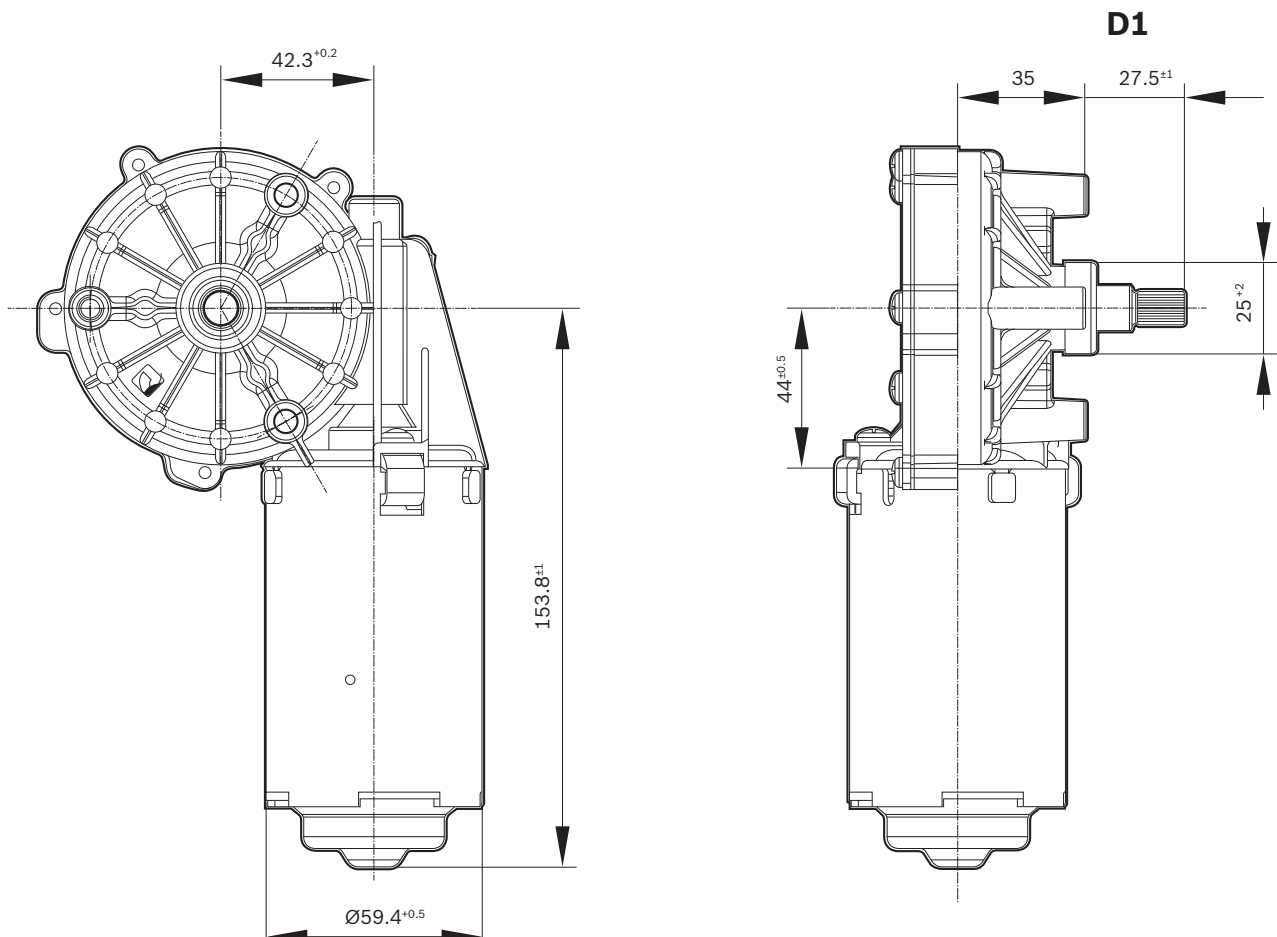

CDP

Wiring diagram (W)

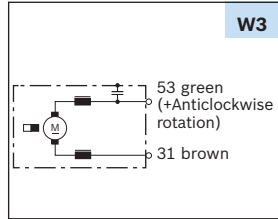
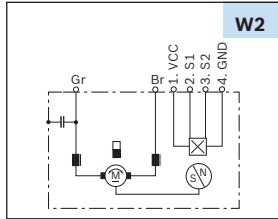
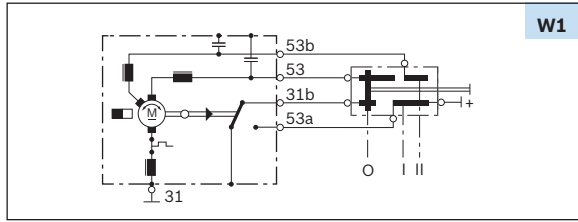

Drive end (S)

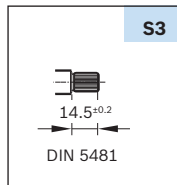
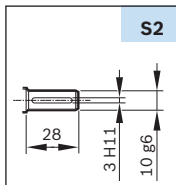
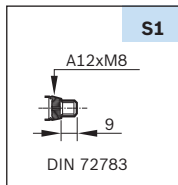

Mating connector (C)

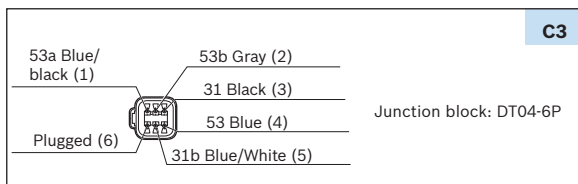
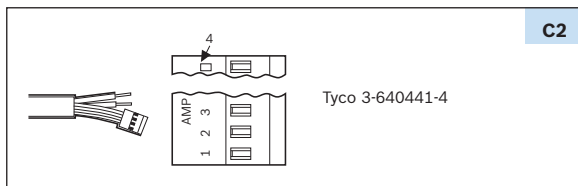
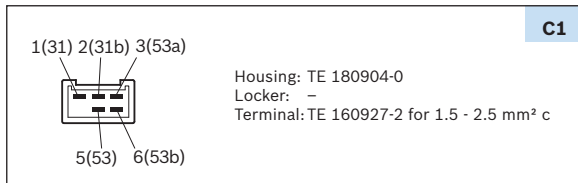

Performance curve (P)

